

Read and save these instructions

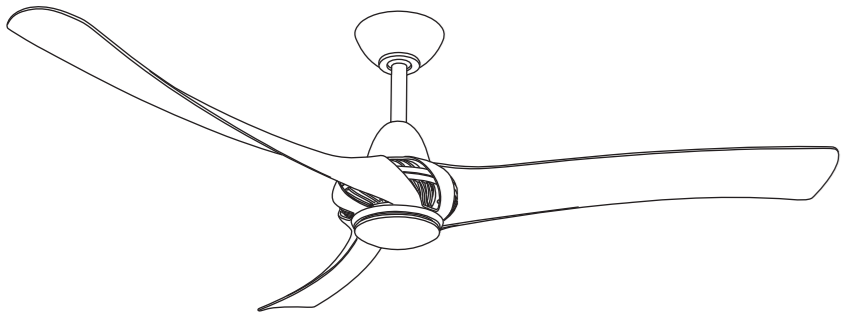

Questions, problems, missing parts? Before returning to your retailer, call our customer service department at 855-817-WIND (9463) 8 a.m. - 5 p.m., EST, Monday-Friday E-mail: service@windriver.com



WR1462 SERIES

Speed	Volts	Amps	Watts	RPM	CFM	N.W.	G.W.	C.F.
Low	120	0.261	13.0	61	2354	5.88 kgs (12.94 lbs)	6.98 kgs (15.36 lbs)	1.65 ft.
Medium		0.410	61.3	100	4118			
High		0.614	73.1	158	6692			

NOTE: These are approximate measures. They do not include amps and wattage used by the light kit.

340644010231

Safety tips

- To reduce the risk of electric shock, ensure electricity has been turned off at the circuit breaker or fuse box before beginning.
- All wiring must be in accordance with the National Electrical Code "ANSI/NFPA 70-1999" and local electrical codes. Electrical installation should be performed by a qualified licensed electrician.
- The outlet box and support structure must be securely mounted and capable of reliably supporting a minimum of 35 lbs. Use only UL Listed outlet boxes marked "FOR FAN SUPPORT."
- The fan must be mounted with a minimum of 7 ft. clearance from the trailing edge of the blades to the floor.
- After making electrical connections, spliced conductors should be turned upward and pushed carefully up into the outlet box. The wires should be spread apart with the grounded conductor and the equipment-grounding conductor on one side of the outlet box and ungrounded conductor on the other side of the outlet box.
- All setscrews must be checked and retightened where necessary before installation.

WARNING: To reduce the risk of electrical shock or fire, do not use this fan with any solid-state fan speed control device. Please contact with dealer or Wind River at 855-817-WIND (9463) if using solid-state remote.

WARNING: To reduce the risk of fire, electric shock, or personal injury, mount the fan to the outlet box marked acceptable for fan support with the screws provided with the outlet box.

Package contents

Unpack your fan and check the contents. See page 2. You should have the following items:

- | | |
|-------------------------|---|
| 1. Blade (3) | 7. Fan motor assembly (1) |
| 2. Downrod assembly (1) | 8. Flywheel (1) |
| 3. Mounting bracket (1) | 9. 17W LED assembly (1) |
| 4. Canopy (1) | 10. Receiver with 6 wire nuts (1) |
| 5. Canopy cover (1) | 11. Transmitter + holder + 2mounting screws + A23 12 volt battery (1) |
| 6. Coupling cover (1) | |
10. Loose parts bag containing
A: Machine screw (2) B: Wood screw (2) C: Metal washer (2) D: Lock washer (2) E: Blade screw (10)
F: Flywheel (4) G: Safety bolt (1) H: Nut (1)

Begin installation

Tools Required: Phillips screw driver; slotted screw driver; pliers; wire cutters; electrical tape.

MOUNTING OPTIONS

If there isn't an existing outlet box, then read the following instructions. Shut the power off at the circuit breaker or fuse box. Secure the outlet box directly to the building structure. Use appropriate fasteners and building materials. Only use a U.L. Listed metal outlet box marked "Acceptable for ceiling fan support" to install the ceiling fan. Do not use a plastic outlet box or other device. Figures 1, 2 and 3 are examples of different ways to mount the outlet box. Note: Please contact with dealer or Wind River at 855-817-WIND (9463) if you need a longer downrod to maintain proper blade clearance when installing on a steep, sloped ceiling. To hang your fan where there is an existing fixture but no ceiling joist, you may need to install a hanger bar as shown in Fig. 4.

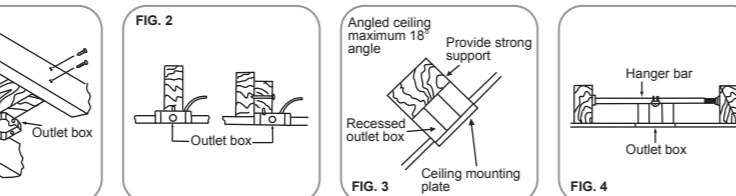
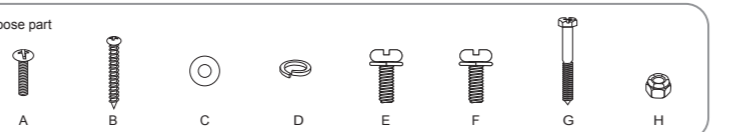
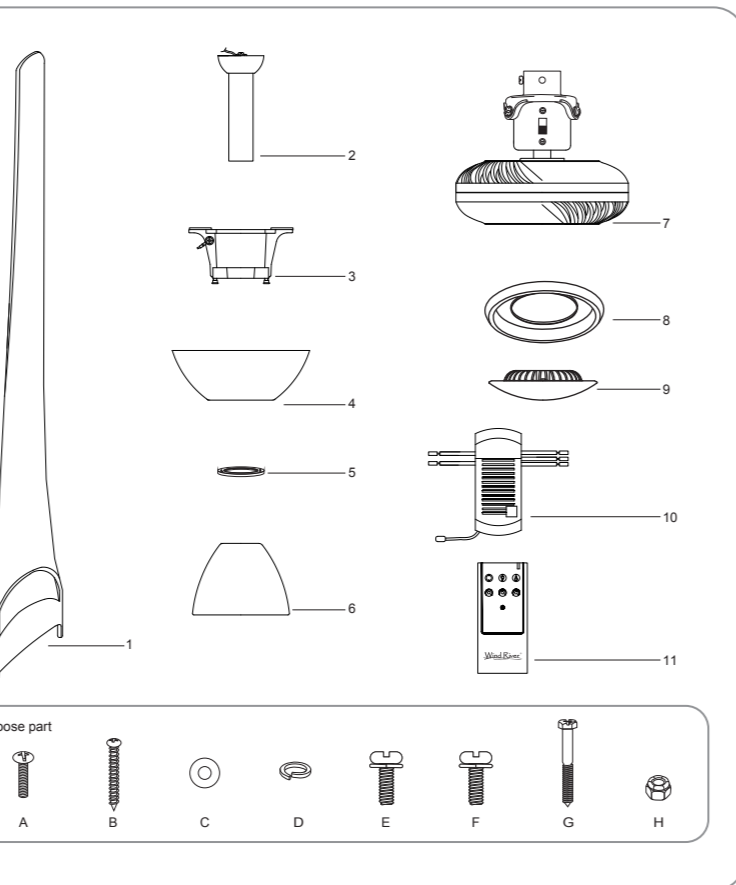

Blade installation

Align the 3 holes from the blade to the fan motor. Secure blade with 3 blade screws provided. Follow the same process for the remaining two blades. (Fig. 5) All blade sets are grouped together by weight.

Hanging the fan

WARNING: Please use all of the parts hardware and components provided by Wind River. The use of other parts, hardware or components not supplied by Wind River with the fan will void the Wind River Warranty.

REMEMBER to turn off the power. Follow the steps below to hang your fan properly:
Step 1. Attach the mounting bracket to the outlet box with two screws and washers provided with the outlet box. Make sure the mounting bracket is tight and secured. (Fig.6)
Step 2. Loosen the two set screws from the top coupling of the motor assembly. (Fig 7)
Step 3. Remove hanger ball from downrod assembly by loosening set screw, removing the cross pin, and sliding ball off rod. (Fig 7)
Step 4. Carefully feed fan wires up through the downrod (Fig 7). Screw the downrod into the coupling. Insert the safety bolt through the coupling and attach the nut. Tighten firmly. (Fig. 9)
Step 5. Slip coupling cover, canopy cover, and canopy onto downrod (Fig.7) Carefully reinstall hanger ball onto rod being sure that cross pin is in the correct position, set screws are tight and wires are not twisted.
Step 6. Now lift motor assembly into position and place hanger ball into hanger bracket. Rotate until the check groove has dropped into the registration slot and seats firmly. (Fig 8) Rod should not rotate if this is done correctly.

Electrical connections

REMEMBER to shut the power off at the circuit breaker or fuse box.
Step 1. Insert Receiver into Hanger Bracket with the flat side of the Receiver facing the ceiling. (Fig. 9)
Step 2. Motor to Receiver Electrical Connections: Connect the WHITE wire from the fan to the WHITE wire marked "TO MOTOR N" from the Receiver. Connect the BLACK wire from the fan to the BLACK wire marked "TO MOTOR L" from the Receiver. Connect the BLUE wire from the fan to the BLUE wire marked "For Light" from the Receiver. (Fig. 10)
Step 3. Receiver to House Supply Wires Electrical connections: Connect the WHITE wire(Neutral) marked from the outlet box to the WHITE wire marked "AC in N" from the receiver. Connect the BLACK wire(Hot) from the outlet box to the BLACK wire marked "AC in L" from the receiver. Secure all wire connections with the plastic wire nuts provided. (Fig. 10)
Step 4. If your outlet box has a GROUND wire (Green or Bare Copper) connect this wire to the Hanger Ball and Hanger Bracket Ground wires. If your outlet box does not have a Ground Wire, then connect the Hanger Ball and Hanger Bracket Ground Wire together. Secure wire connection with the plastic wire nut provided.
After all splices are made, check to make sure there are no loose strands. As an additional precaution we suggest to secure the plastic wire connectors to the wires with electrical tape.

Finishing the installation

Step 1. Remove one screw from the mounting bracket and loosen the other screw approximately 1/4 turn. Step 2. Carefully raise the canopy up to the mounting bracket, and ensure the loosened screw is inserted into the key hole on the canopy. Rotate the canopy clockwise. (Fig. 11)
Step 3. Secure the canopy by replacing the screw previously removed and tightening the screw previously loosened. (Fig. 11)
Step 4. Place the canopy cover on the canopy, and rotate the canopy cover clockwise until it locks into position. (Fig. 11)

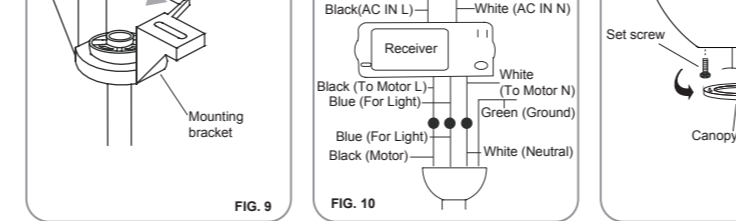
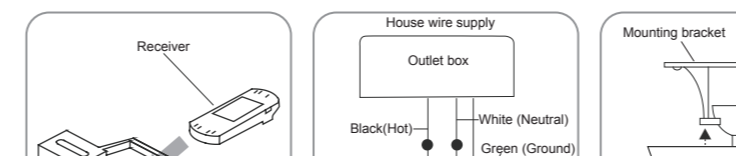
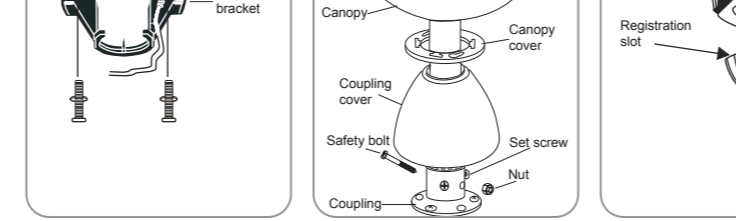
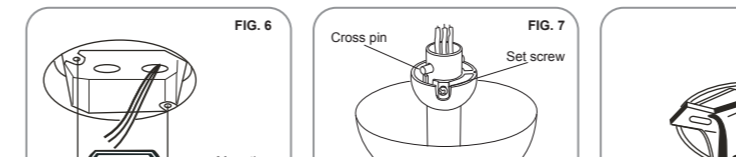
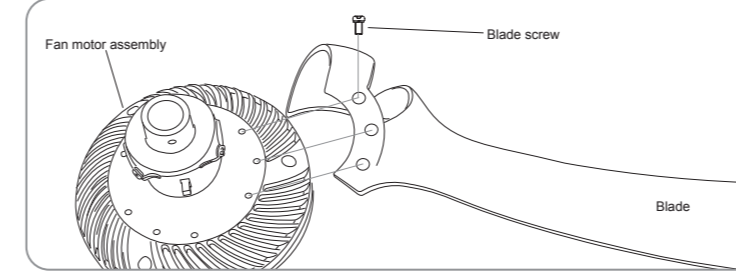

Installing the light kit

Step 1. Align holes in the flywheel and the fan motor assembly, and secure with the screw. Ensure all the screws are tightened. (Fig. 12)
Step 2. While holding the 17W LED assembly under your fan, firmly snap the wire connection plugs together. (Fig.13)
Step 3. Attach the 17W LED assembly to the switch box by twisting tightly.

Operation

Install a 12V battery into the remote control. To prevent damage to the remote control, remove the battery if not used for long periods of time. Turn on the power and check the operation of your fan. a. "On", "Off", "On" and "Off" buttons: These three buttons are used to select the fan speed. Press and release the button of the desired speed setting: On = Lowest speed, Off = Medium speed, On = Highest speed. b. "Dim" button: This button will turn the light on or off and will also control the brightness setting. Press and release the button and the light will turn on or cycle continuously between bright and dim settings as long as the button is held down. The light key has auto resume, it will stay at the same brightness as the last time it was turned off. c. "Fan" button: This button will turn the fan off.

The reverse switch is located on the switch box. This switch controls directions: forward (switch down) or reverse (switch up).

NOTE: Wait for the fan to stop before reversing the direction of the blade rotation. Warm weather - (Counterclockwise Direction) A downward air flow creates a cooling effect. This allows you to set your air conditioner on a higher setting without affecting your comfort. (Fig 15)
Cool weather - (Clockwise Direction) An upward air flow moves warm air off the ceiling. This allows you to set your heating unit on a lower setting without affecting your comfort. (Fig 16)

Care and Cleaning

Check the support connections, brackets, and blade attachments twice a year. Ensure they are secure. Because of the fan's natural movement, some connections may become loose over time. It is not necessary to remove the fan from the ceiling. Clean your fan periodically. Use only a soft brush or lint-free cloth to avoid scratching the finish. The plating is sealed with a lacquer to minimize discoloration or tarnishing. (Optional) Apply a light coat of furniture polish to the wood blades. (Optional) Cover small scratches with a light application of shoe polish. Do not use water when cleaning. Water could damage the motor, or the wood, or possibly cause an electrical shock. Do not apply oil to your fan or motor. The motor has permanently-lubricated sealed ball bearings.

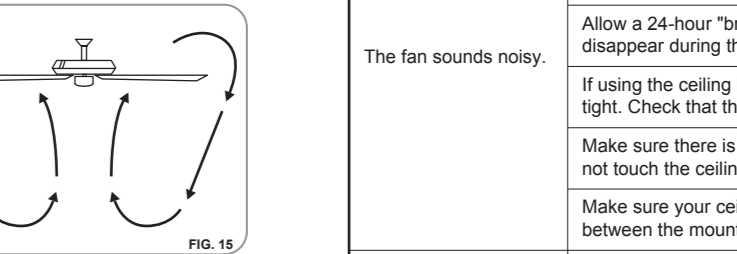
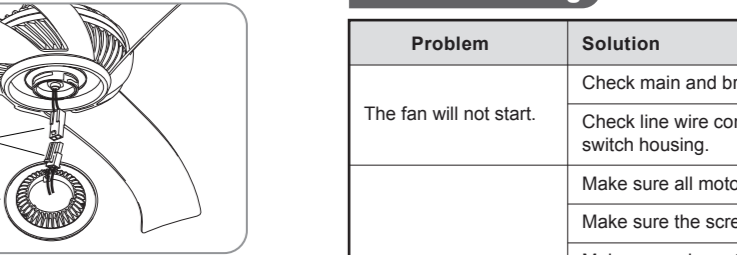
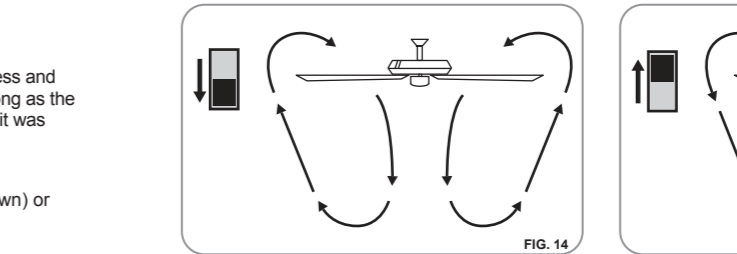
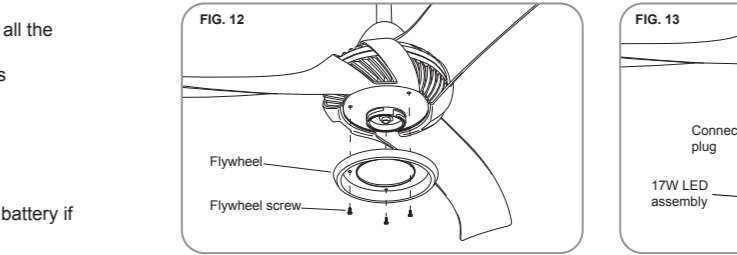

Troubleshooting

Problem	Solution
The fan will not start.	Check main and branch circuit fuses or breakers. Check line wire connections to the fan and switch wire connections in the switch housing.
The fan sounds noisy.	Make sure all motor housing screws are snug. Make sure the screws that attach the fan blade arm to the motor hub are tight. Make sure wire nut connections are not rattling against each other or the interior wall of the switch housing. Allow a 24-hour "breaking-in" period. Most noises associated with a new fan disappear during this time. If using the ceiling light kit, make sure the screws securing the glassware are tight. Check that the light bulb is also secure. Make sure there is a short distance from the ceiling to the canopy. It should not touch the ceiling. Make sure your ceiling box is secure and rubber isolator pads are used between the mounting bracket and outlet box.
The fan wobbles.	Check that all blade and blade arm screws are secure. Most fan wobble problems are caused when blade levels are unequal. Check this level by selecting a point on the ceiling above the tip of one of the blades. Measure from a point on the center of each blade to the point on the ceiling. Rotate the fan until the next blade is positioned for measurement. Repeat for each blade. Measurements deviation should be within 1/8 in. Run the fan for 10 minutes. Use the enclosed blade balancing kit if the blade wobble is still noticeable.

